

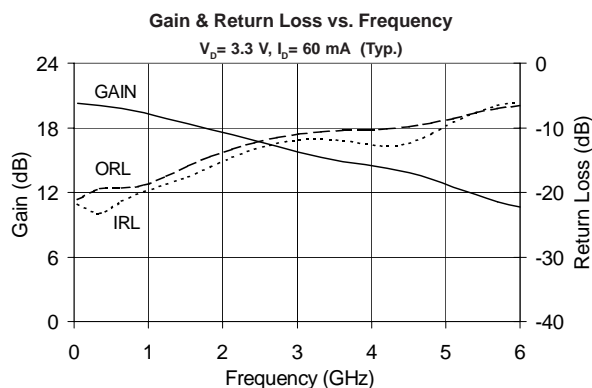

## Product Description

The SGA-5489 is a high performance SiGe HBT MMIC Amplifier. A Darlington configuration featuring 1 micron emitters provides high  $F_T$  and excellent thermal performance. The heterojunction increases breakdown voltage and minimizes leakage current between junctions. Cancellation of emitter junction non-linearities results in higher suppression of intermodulation products. Only 2 DC-blocking capacitors, a bias resistor and an optional RF choke are required for operation.

The matte tin finish on Sirenza's lead-free package utilizes a post annealing process to mitigate tin whisker formation and is RoHS compliant per EU Directive 2002/95. This package is also manufactured with green molding compounds that contain no antimony trioxide nor halogenated fire retardants.



Symbol	Parameter	Units	Frequency	Min.	Typ.	Max.
G	Small Signal Gain	dB	850 MHz	17.7	19.7	21.7
		dB	1950 MHz		17.9	
		dB	2400 MHz		17.1	
$P_{1dB}$	Output Power at 1dB Compression	dBm	850 MHz		16.0	
		dBm	1950 MHz		14.6	
$OIP_3$	Output Third Order Intercept Point	dBm	850 MHz		30.8	
		dBm	1950 MHz		27.4	
Bandwidth	Determined by Return Loss (>10dB)	MHz			4000	
IRL	Input Return Loss	dB	1950 MHz		15.4	
ORL	Output Return Loss	dB	1950 MHz		14.0	
NF	Noise Figure	dB	1950 MHz		2.4	
$V_D$	Device Operating Voltage	V		3.1	3.3	4.1
$I_D$	Device Operating Current	mA		54	60	66
$R_{TH}$ , j-I	Thermal Resistance (junction to lead)	$^{\circ}\text{C}/\text{W}$			97	
<b>Test Conditions:</b>		$V_S = 8 \text{ V}$	$I_D = 60 \text{ mA Typ.}$	$OIP_3$ Tone Spacing = 1 MHz, $P_{out}$ per tone = 0 dBm		
		$R_{BIAS} = 75 \text{ Ohms}$	$T_L = 25^{\circ}\text{C}$	$Z_S = Z_L = 50 \text{ Ohms}$		

## SGA-5489

## SGA-5489Z RoHS Compliant & Green Package

DC-4000 MHz, Cascadable  
SiGe HBT MMIC Amplifier



## Product Features

- Now available in Lead Free, RoHS Compliant, & Green Packaging
- High Gain : 17.9 dB at 1950 MHz
- Cascadable 50 Ohm
- Operates From Single Supply
- Low Thermal Resistance Package

## Applications

- PA Driver Amplifier
- Cellular, PCS, GSM, UMTS
- IF Amplifier
- Wireless Data, Satellite

**Typical RF Performance at Key Operating Frequencies**

Symbol	Parameter	Unit	Frequency (MHz)					
			100	500	850	1950	2400	3500
G	Small Signal Gain	dB	20.2	19.9	19.7	17.9	17.1	15.0
OIP <sub>3</sub>	Output Third Order Intercept Point	dBm		31.3	30.8	27.4	25.7	
P <sub>1dB</sub>	Output Power at 1dB Compression	dBm		16.3	16.0	14.6	13.5	
IRL	Input Return Loss	dB	22.4	22.3	20.2	15.4	13.5	11.8
ORL	Output Return Loss	dB	20.5	19.4	19.1	14.0	12.4	10.4
S <sub>12</sub>	Reverse Isolation	dB	24.8	23.2	23.4	23.5	23.1	21.1
NF	Noise Figure	dB		3.0	2.8	2.4	3.7	

**Test Conditions:** V<sub>S</sub> = 8 V, I<sub>D</sub> = 60 mA Typ., OIP<sub>3</sub> Tone Spacing = 1 MHz, Pout per tone = 0 dBm  
R<sub>BIAS</sub> = 75 Ohms, T<sub>L</sub> = 25°C, Z<sub>S</sub> = Z<sub>L</sub> = 50 Ohms

**Noise Figure vs. Frequency**

V<sub>D</sub> = 3.3 V, I<sub>D</sub> = 60 mA

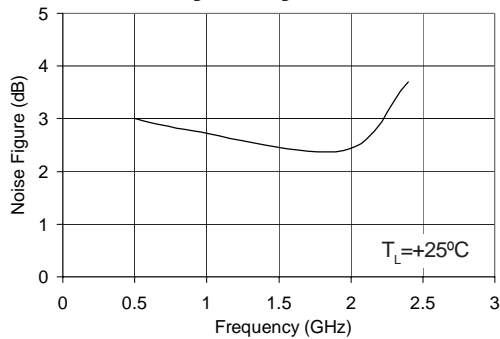

**Absolute Maximum Ratings**

Parameter	Absolute Limit
Max. Device Current (I <sub>D</sub> )	120 mA
Max. Device Voltage (V <sub>D</sub> )	5 V
Max. RF Input Power	+16 dBm
Max. Junction Temp. (T <sub>J</sub> )	+150°C
Operating Temp. Range (T <sub>L</sub> )	-40°C to +85°C
Max. Storage Temp.	+150°C

Operation of this device beyond any one of these limits may cause permanent damage. For reliable continuous operation, the device voltage and current must not exceed the maximum operating values specified in the table on page one.

Bias Conditions should also satisfy the following expression:  
 $I_D V_D < (T_J - T_L) / R_{TH} j-I$

**OIP<sub>3</sub> vs. Frequency**

V<sub>D</sub> = 3.3 V, I<sub>D</sub> = 60 mA

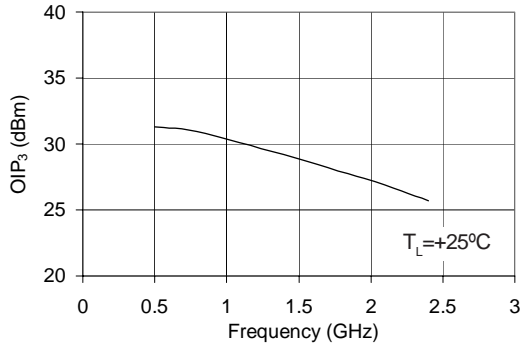

**P<sub>1dB</sub> vs. Frequency**

V<sub>D</sub> = 3.3 V, I<sub>D</sub> = 60 mA

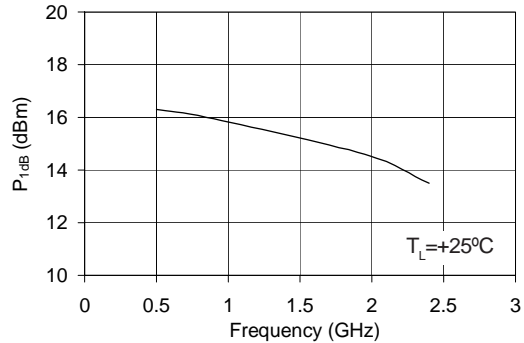

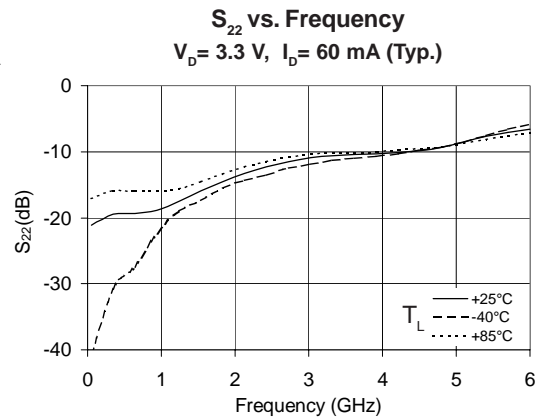
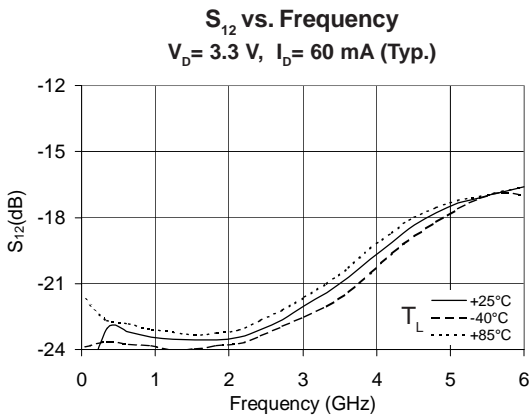
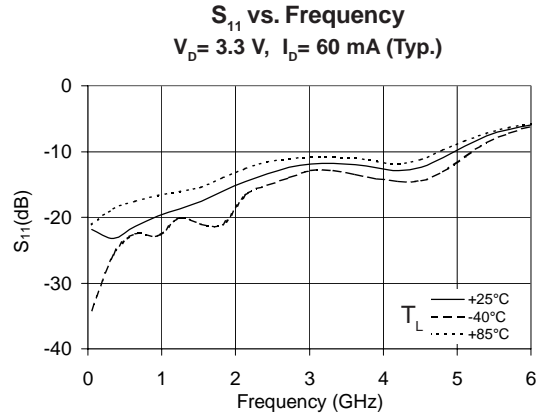
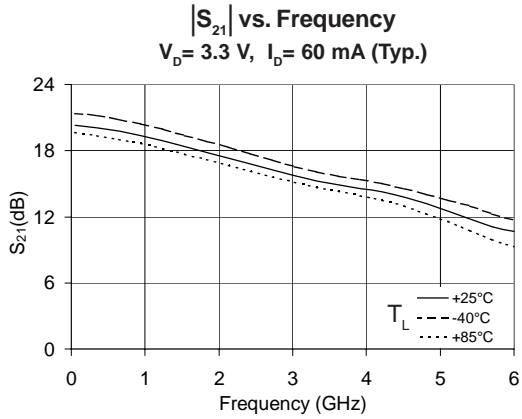

NOTE: Full S-parameter data available at [www.sirenza.com](http://www.sirenza.com)

**Basic Application Circuit**

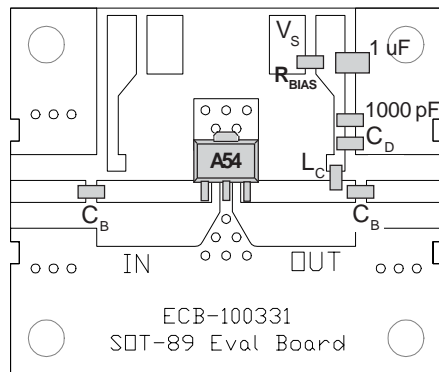
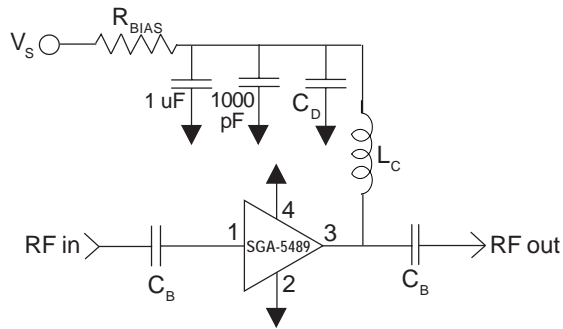

**Part Identification Marking**

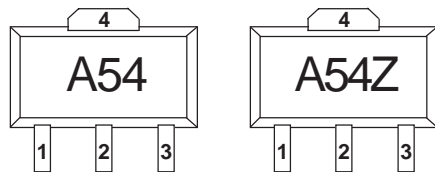

**Caution: ESD sensitive**  
Appropriate precautions in handling, packaging and testing devices must be observed.

**See Application Note AN-075  
for Package Outline Drawing**

**Application Circuit Element Values**

Reference Designator	Frequency (Mhz)				
	500	850	1950	2400	3500
C <sub>B</sub>	220 pF	100 pF	68 pF	56 pF	39 pF
C <sub>D</sub>	100 pF	68 pF	22 pF	22 pF	15 pF
L <sub>C</sub>	68 nH	33 nH	22 nH	18 nH	15 nH

**Recommended Bias Resistor Values for I<sub>D</sub>=60mA**  
 $R_{BIAS} = (V_S - V_D) / I_D$

Supply Voltage (V <sub>S</sub> )	6 V	8 V	10 V	12 V
R <sub>BIAS</sub>	43 Ω	75 Ω	110 Ω	150 Ω

Note: R<sub>BIAS</sub> provides DC bias stability over temperature.

**Mounting Instructions**

- Solder the copper pad on the backside of the device package to the ground plane.
- Use a large ground pad area with many plated through-holes as shown.
- We recommend 1 or 2 ounce copper. Measurement for this data sheet were made on a 31 mil thick FR-4 board with 1 ounce copper on both sides.

Pin #	Function	Description
1	RF IN	RF input pin. This pin requires the use of an external DC blocking capacitor chosen for the frequency of operation.
2, 4	GND	Connection to ground. Use via holes for best performance to reduce lead inductance as close to ground leads as possible.
3	RF OUT/ BIAS	RF output and bias pin. DC voltage is present on this pin, therefore a DC blocking capacitor is necessary for proper operation.

**Part Number Ordering Information**

Part Number	Reel Size	Devices/Reel
<b>SGA-5489</b>	<b>13"</b>	<b>3000</b>
<b>SGA-5489Z</b>	<b>13"</b>	<b>3000</b>